

Front plate

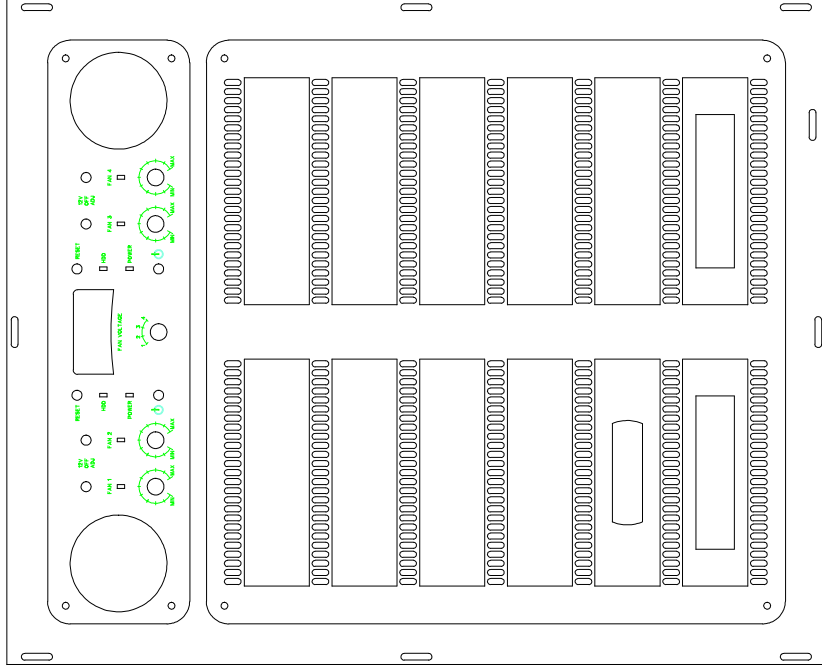
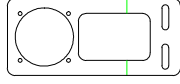

Plate support 2x



Volt meter stand



Computer Desk		
Front plate		
AUTHOR	Petri Damsten	
LICENSE	GPL	SHEET 1/5
DATE/IV.	24.09.2003/1.0	SCALE 1:5

Side 2x

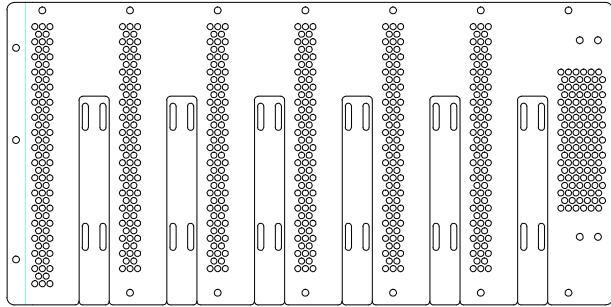

Side 2x

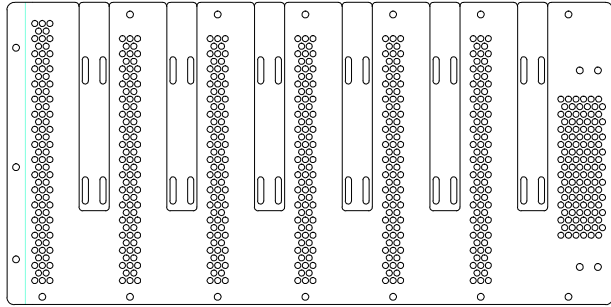

Top

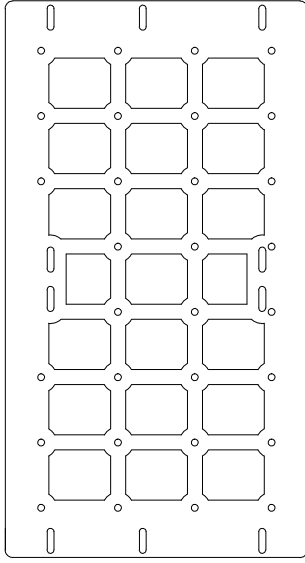

Drive bay legs 8x



Drive holders 24x

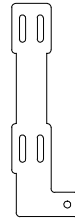

Motherboard support 1x

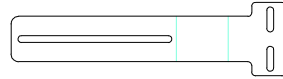

Front plate support 2x



Side support 2x



Computer Desk

Drive bays

AUTHOR Petri Damsten

LICENSE GPL

DATE/IV. 24.09.2003/1.0

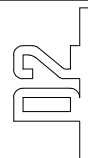

SHEET 2/5

SCALE 1:5

Motherboard stand

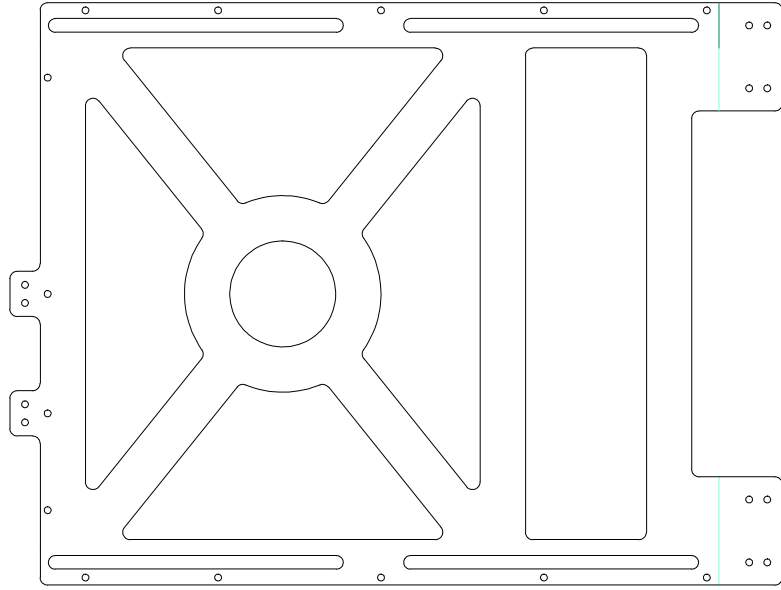

Motherboard plate 2x

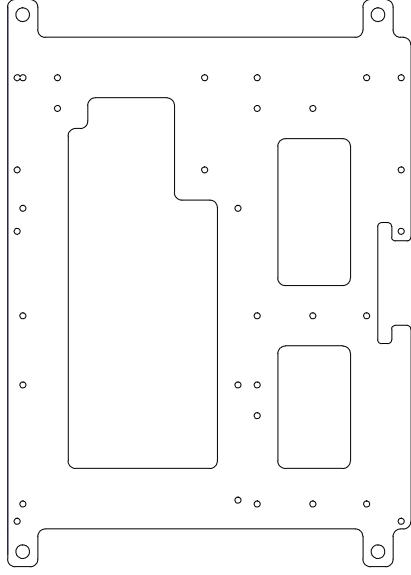

Front support

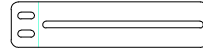

Back support



PCI card support 2x

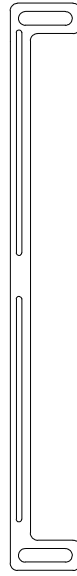

Computer Desk
Motherboard

AUTHOR Petri Damsten

LICENSE GPL

DATE/IV. 24.09.2003/1.0



SHEET 3/5

SCALE 1:5

Out

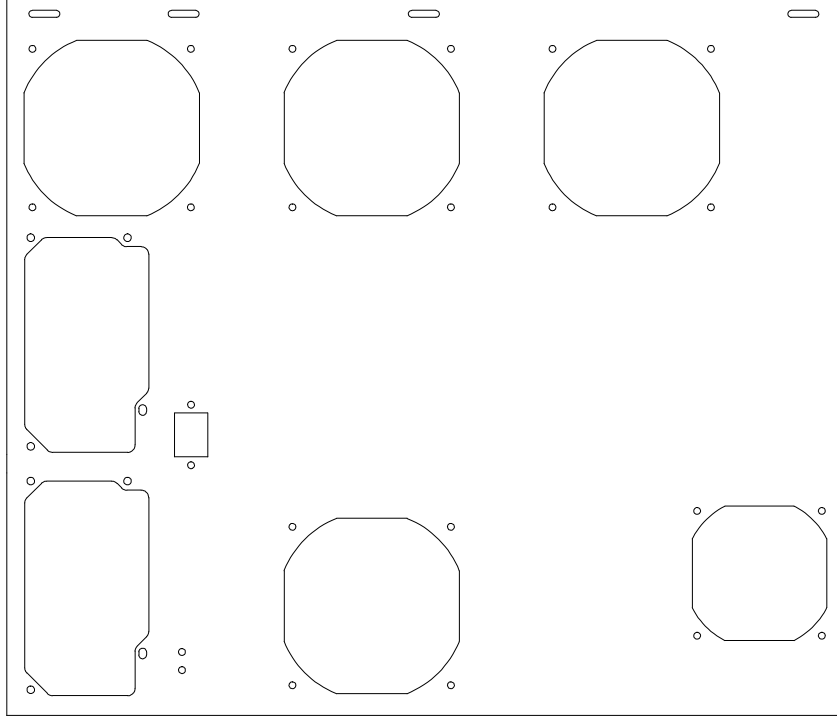

In

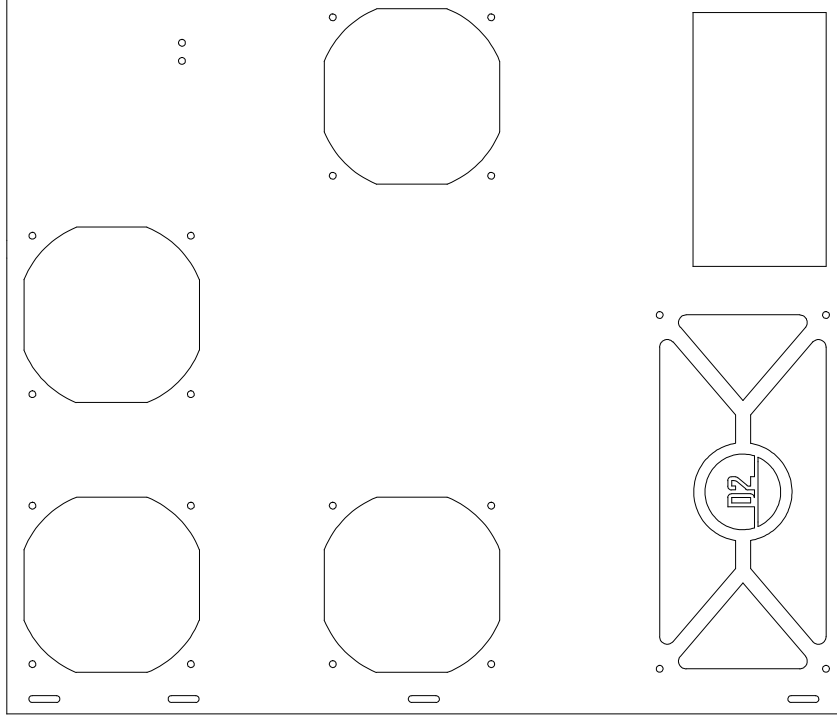

Side support 2x



Fan plate 6x

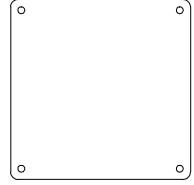

Power supply plate 1x

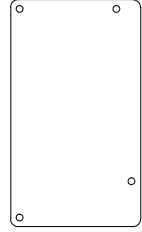

Ventilation hole plate 1x

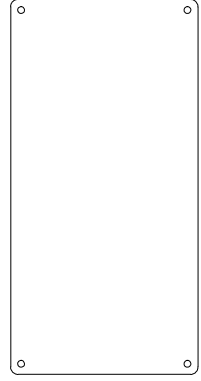

Computer Desk

Side plates

AUTHOR Petri Damsten

LICENSE GPL

DATE/IV. 24.09.2003/1.0



SHEET 4/5

SCALE 1:5

Lock bracing



Shelves 6x

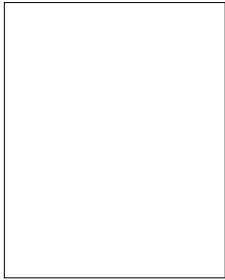

Computer Desk	
Misc	
AUTHOR	Petri Damsten
LICENSE	GPL
DATE/V.	24.09.2003/1.0

DZ	
SHEET	5/5
SCALE	1:5

1250

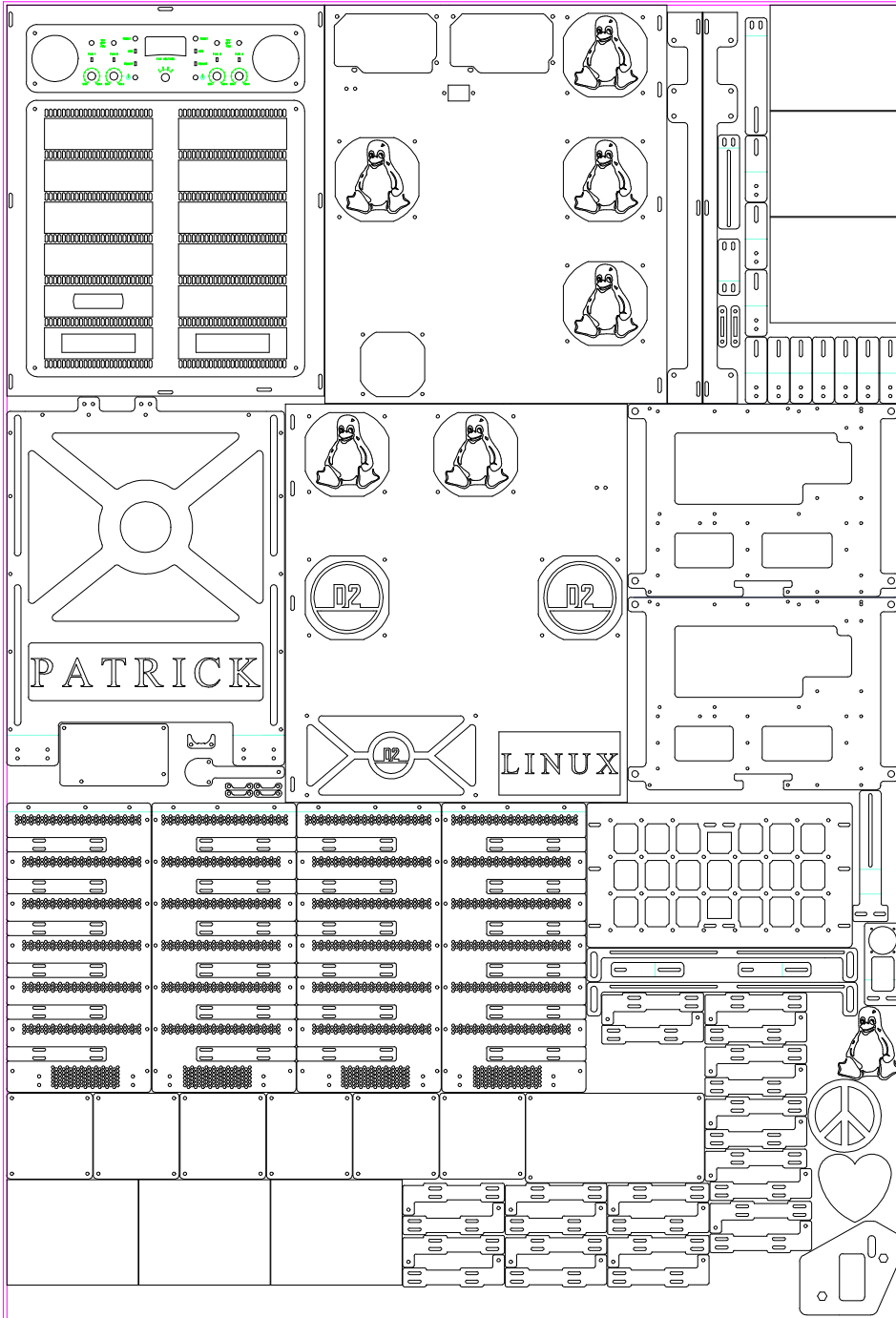

2500